

VOLVO MOTOR GRADERS

**G930, G940
G946, G960**



MORE CARE. BUILT IN.



TRADITIONAL VALUES. ADVANCED PERFORMANCE.

The G900 family of Motor Graders is firmly rooted in the technologies and values of Volvo worldwide.

More care. Built in.

Volvo Construction Equipment makes this promise to customers everywhere: every Volvo machine will satisfy your highest expectations for equipment that's productive, operator-friendly, reliable and easy to service. Now, traditional Volvo values and performance extend to four new motor graders powered by the renowned D7E Volvo engine, all designed, built and tested to keep that same promise in every way.

The Volvo way

The complete family of seven G900 Motor Graders includes four Volvo D7E- and three Volvo D9B-powered models. These machines deliver on the promise of "More care. Built in." through a combination of proven Volvo technologies and processes:

- bottom-line productivity on the job site
- a safe and comfortable operator environment
- long lasting reliability
- unmatched ease of serviceability with low maintenance demands

This series of Volvo Motor Graders includes three highly efficient and versatile tandem-drive models: G930, G940 and G960 as well as the G946 machine with the industry-leading Volvo All Wheel Drive (AWD) and the original "Creep Mode" front-wheel-only hydrostatic drive. The result is a selection of graders with outstanding power, torque and fuel efficiency for the widest range of grader applications.

Quality with confidence

No family of motor graders anywhere has been subject to more rigorous testing than Volvo G900 Motor Graders. By listening to customer needs and responding with design innovations like the industry's first 11-speed grader transmission with autoshift, the Volvo continuous improvement program leads the G900 family to ongoing quality leadership.

At home in the Volvo fleet

From end-to-end, from the ground up, the G900 Motor Graders are fit and finished to take their place in your fleet. Design details and their renowned Volvo Care Cab provide a familiar work environment inside and out for owners and operators of any Volvo machine.

Care for the environment, one of the Volvo core values, is reflected in the environmental performance of the G900 Motor Graders. The G900 family meets EU Stage IIIA and US Tier 3 Emission Regulations as well as EU noise standards. Volvo engineering minimizes whole body vibration to maximize operator productivity.

For grader operators and owners everywhere, the G900 Motor Graders means a new standard in grading performance and productivity. The Volvo standard.

Volvo Motor Graders industry firsts

1975

- Full perimeter rear frame with modular powertrain design
- Optional first-user frame warranty now including maintenance-free articulation pins and bearings

1984

- First electronically controlled transmission with on board diagnostics

1991

- Duramide™, the first synthetic circle support bearing material that prevents metal to metal contact
- Hydraulically operated, oil-bathed multiple disc brakes standard
- Dual crossover brake circuits

1999

- "Creep Mode", a front-wheel-only hydrostatic drive system
- AWD with separate variable displacement pumps
- Glare-reducing paint scheme

2002

- Tier II emission compliant
- Most powerful All Wheel Drive Grader

2006

- Tier 3 emission compliant
- 11-speed grader transmission with switchable manual, auto-shift and transport modes
- Shuttle shift capability with straight line forward to reverse shift pattern
- High performance three sided cooling module with a swing out fan for easy cleaning

2008

- Two person training cab - ROPS / FOPS certified
- European Union directive EN474:2006 compliant
- Fuel saving engine 'Power' mode standard with optional 'Speed' mode (N/A within EU market)



Volvo G900 Motor Graders

‡ With All Wheel Drive engaged

Model		G930	G940	G946	G960	G970	G976	G990
Base operating weight - approximate	kg (lb)	15 800 (34,830)	16 400 (36,150)	17 300 (38,140)	17 550 (38,690)	18 900 (41,660)	19 800 (43,650)	22 100 (48,720)
Engine model/displacement		D7E/7.2 L	D7E/7.2 L	D7E/7.2 L	D7E/7.2 L	D9B/9.4 L	D9B/9.4 L	D9B/9.4 L
Base range net power	kW (hp)	115 (155)	130 (175)	145* (195*)	145 (195)	156 (210)	168* (225*)	168 (225)
Mid range net power	kW (hp)	130 (175)	145 (195)	160* (215*)	160 (215)	171 (230)	183* (245*)	183 (245)
High range net power	kW (hp)	145 (195)	160 (215)	175* (235*)	175 (235)	186 (250)	198* (265*)	198 (265)



STRONGER. TOUGHER. FINER. SMARTER.

From heavy cutting to fine finishing, G900 Motor Graders work with grader operators to perform every task efficiently, profitably.

Power on demand

With the G900 Motor Graders, Volvo puts the keys to new levels of profitable grader performance in your hands. What you'll notice first, is the power. Dig into the job and Volvo digs in with you. Volvo engines are renowned for high torque at low RPMs, producing responsive, fuel-efficient performance under all operating conditions. When you call for power and smooth responsive moldboard control, your Volvo G900 Motor Grader comes through without hesitation.

Then there's the touch

Highly responsive industry-standard controls give skilled operators the sure feel they need to do what they do best. Wide stance blade lift cylinders coupled with the low angle side shift cylinder provide the most stable grading platform in the industry. Heavy-duty inching clutches and a powerful twin-gear direct-drive circle turn system translate responsive control into precise earthmoving results. You get more one-pass finishes with cost-saving accuracy.

Precise and predictable

Volvo's Proportional Demand Flow (PDF) hydraulic system, balances flow between all grading functions for consistent and predictable implement control. The G900 PDF hydraulic system is ideally suited for all leading Automatic Blade Control systems.

Gearing up for the bottom line

Volvo HTE transmissions, including standard 8-speed and optional 11-speed models, translate engine output into intelligent power for faster, simpler duty cycles. With selectable Manual, optional Autoshift and Travel modes, your choice of G900 Motor Graders offers power and speed the way you want it, when you want it. With the Volvo Autoshift mode, you just select your gear and go. Your Volvo HTE transmission does the rest to get you up to speed in your working or travel gear ranges quickly, economically and smoothly. Volvo shuttle shift, a standard feature on all Volvo Grader transmissions, allows operators to make effortless, forward-to-reverse shifts (and vice versa) without stopping or using the inching pedal. In jobs that require frequent direction changes, shuttle shifting means faster cycle times, less fatigue and more work done at day's end.

Turning the Corner

The G900 Series introduced a new concept to motor grader thinking: a longer wheelbase that can turn in tighter circles! The long G900 wheelbase ensures greater stability and fine grade control and also improves the sight line to the leading tandem wheels, helping operators run closer to grade markers. For improved mobility in tight spaces, a low maintenance front axle gives the G900 Series a reduced turning circle with its 50° steering range and a large 23° articulation angle. The G900 Graders not only make the grade but follow it, too.





HTE1160: the first 11-speed grader transmission

With 11 forward speeds and 6 reverse, the optional HTE1160 from Volvo expands the gear range of the grader to offer more control in the low-speed range, more efficient travel speed in the high range, more precision in the working range and exceptional fuel efficiency for every task.

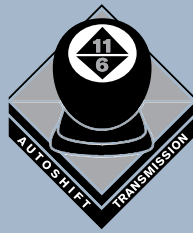

The HTE1160 comes standard with Volvo Autoshift, combining maximum control with ultimate simplicity of operation.



THE RIGHT TOOLS IN THE RIGHT HANDS.

Volvo knows that you only get the best from your machine when you get the best from your operator – so we made experienced operators part of our design team!

New ideas for old hands

Any tool is only as good as the person using it. So when Volvo designed the G900 Motor Graders, we started with grader operators.

Making the best, better

Of course, we began with familiar, industry-standard grader controls that come easily to hand. But we gave them a more responsive feel, plus low-effort levers and low-effort pedals to make long hours easier. We devised an interior layout that puts all operational controls right where you need them. Then surrounded it with the industry's most spacious compartment plus a pedestal and seat that adjust to fit the space to the operator. We added a Volvo Contrinsic Monitoring System with a smart display console that tells operators everything they need to know about the machine at a glance, in multiple languages. But we also cleared exterior lines of sight with exceptional floor-to-roof visibility through the front, down to the moldboard and close in to the sides. Plus an unequalled rear view. A Volvo Care Cab, in every sense.

Accurate grading

When site specifications call for precise grade control, the Volvo G900 comes through. Volvo worked with the leading manufacturers of Automatic Blade Control systems and developed the G900 family with the contractor in mind.

The result – optional mounting brackets, hydraulic and electrical connections designed exclusively for machine control systems. Even the pedestal head has mounting locations for grade displays. So no matter what brand of machine control you currently use, the G900 is ready.

Know what you're getting into

Open the cab door to your Volvo Motor Grader – then, with automatic illumination set for the steps and handholds, you step up to the industry's easiest entry and exit. Inflows of outside air are easily adjusted for maximum cab pressurization or increased re-circulation for fast warm-ups or cool downs. With extensive noise and vibration suppression designed into the cab and with the quiet-running Volvo engine behind, operators spend the day in peace and quiet.

For hard-working people

Volvo works hard to keep operators at their best all day long. A high capacity, 12-speed fan pushes fresh, double-filtered air throughout the cab via 10 well-placed outlets. Window options on the front and sides open wide for natural ventilation or to minimize glare. High capacity air conditioning and heating systems keep temperatures comfortable in any season. A wide range of comfort amenities and ergonomic design features make G900 Motor Graders a great place to spend the working day.





The Volvo Care Cab:

Standard:

- 72 dB(A) Enclosed cab
- Contronic Monitoring System
- 50,000 BTU heater with 10 outlets
- Two high capacity air filters
- Interior lights
- Illuminated entry
- Non-skid steps
- Cup holder and ashtray
- Coat hook
- Storage compartments

Optional:

- 30,000 BTU air conditioner
- Wide-angle wiper pattern (for low profile cab)
- Air suspension seat
- Opening side windows
- Opening lower front windows
- Lunch box and thermos
- Radio/CD player with four speakers

...and much more!



RELAX. IT'S A VOLVO!

There's a new benchmark for performance in the grading industry, backed by Volvo.

All in the family

Built on a solid foundation of field proven Volvo components including the D7E engine, Volvo transmissions and the Contronic Monitoring System. G900 Motor Graders have been engineered with years of reliable service already built in.

Keep on rolling

Trust Volvo G900 Motor Graders for a long life of hard work.

The modular Volvo assembly process and precise welding technology ensure uniform end-to-end strength in all structural components for lasting durability.

With their modular powertrain design concept, G900 Motor Graders simplify maintenance on major components and allow new levels of flexibility for optimal service scheduling.

Volvo Planetary Reduction Axles with operator-controlled hydraulic clutch differential lock deliver power to the ground efficiently while ensuring dependable long-life service. In every detail, G900 Motor Graders reflect the Volvo commitment to lasting value.

Fade resistant, hydraulically actuated, wet multiple disc service brakes located at the 4 tandem drive wheels are fully sealed and maintenance free. System features crossover dual braking circuits for uniform braking on both sides of the grader. Includes reserve power assist and operator warning system.

Day after day

At Volvo, the details make the difference in day-to-day reliability: extra-strength abrasion resistant hydraulic hoses; sealed electrical connectors; fuse panel connections kept clean and dry inside the cab; premium O.R.F.S. hydraulic couplings along with smart routing of hoses and wiring resist wear and abrasion.

An innovative tandem drive chain design, that maintains its strength and durability while reducing downtime, eliminates the need for press-fit master links and the special tools that are needed to service them.

Exclusive Volvo Contronic Monitoring System provides three levels of intelligence to keep your grader at its peak: continuous minute-by-minute function monitoring; detailed data storage for easy service and troubleshooting; and is easily updated by your Volvo technician. Backed by Volvo Customer Service, G900 Motor Graders bring together the people and the technology for reliable everyday performance.

Year after year

Built for work in the real world and offering superb customer protection, the G900 frame is available with an optional first user lifetime warranty. This industry exclusive warranty also includes the maintenance-free articulation pins and bearings for continuous peace of mind. Ask for G900 warranty documentation. See the details!





Real world flexibility

G900 Motor Graders are purpose-built with a true tool-carrier frame designed to withstand the rigors of all-season service. Field-proven through years of grader service, the Volvo full perimeter rear frame is designed not only to provide effective support for all rear and side attachments, but also permits modular mounting of all major powertrain components. As a result, the powertrain

is easily serviced while being well protected from the severe load stresses of ripping, scarifying, plowing, pushing and snow clearing.

With attachments built and approved by Volvo, G900 Motor Graders adapt to year-round duties without compromising design integrity.



MORE UPTIME. LESS UPKEEP.

G900 Motor Graders reflect the Volvo commitment to equipment that spends more time on the job, less time in the shop.

Ease of service, low maintenance demands

G900 Motor Graders carry on the Volvo approach to maximum uptime: minimize the machine's need for service, then simplify the service tasks it does require.

Sensible service design starts with easy ground-level fueling and minimal grease points, with no daily greasing required. Sight glasses and level sensors make daily checks virtually effortless. All engine service points are conveniently accessed through the left side panel.

Exclusive long-wearing Duramide™ circle support bearings prevent metal-to-metal contact to keep critical tolerances tight and the circle turning smoothly.

Changing the Duramide bearings on the moldboard slide rail is fast and easy - simply remove 4 bolts and slide the lower sleeve bearing out! The top bearing is shielded from dirt spillover, so it wears longer and maintains tighter blading tolerances.

Open for business

With an "Easy Lift" rear hood, gull-wing side panels and removable hydraulic tank cover, G900 Motor Graders are unrivaled for easy routine service. The complete rear cowling opens wide to allow quick, thorough service checks, then back to work quickly.

Keep it simple, smart

The hydraulic system is designed for fast manual or pressure fills through the top of the tank. All added fluids must pass through a large, full flow return filter to prevent accidental contamination in the

reservoir that could lead to down time. Hoses are routed over the surface of the frame for simple inspections.

The Volvo cooling module eliminates stacked cores. Instead, multiple cooling cores are positioned to receive fresh, cool ambient air continuously. A thermostatically controlled, hydraulically driven fan maximizes available power and fuel savings. An auto-reversing cooling fan option allows continuous self-cleaning to further improve cooling performance and reduce service needs.

CareTrack: Everything you want to know

All G900 Motor Graders can be equipped with CareTrack, a remote monitoring system developed by Volvo Construction Equipment. The system collects machine data which can be wirelessly transferred to a computer. The machine data displayed remotely includes: machine position, operating hours, fuel consumption, alarms and more*.

CareTrack makes it easier to plan for service and reduces costly downtime. It also helps eliminate unauthorized usage and theft by using virtual fences to restrict the operating area of the machine.

*May vary by machine model and/or subscription.





V-ACT

The new generation of D7E engines with Volvo Advanced Combustion Technology (V-ACT) is tailored for grader applications, designed to run cleanly and efficiently without the extra service requirements of additional equipment or after-treatment of exhaust gases.

ALL-PURPOSE ALL WHEEL DRIVE.

The All Wheel Drive G946 Motor Grader is unmatched for pure versatility.

The drive to succeed

When you're looking for excellence in every grader task, Volvo All Wheel Drive is the grader that gets you there. Having a Volvo AWD is like having three drive systems in one: a highly efficient 4-wheel tandem drive, a powerful 6-wheel drive plus the exclusive Volvo Creep Mode, the industry's original hydrostatic front-wheel-only drive for exceptional fine-grading control.

A firm footing for AWD

The Volvo AWD system is built around two variable displacement axial piston pumps feeding direct drive wheel motors: no planetary gear reductions, no clutch packs. Pump displacement is controlled in response to the aggression switch setting for precise wheel power control. The system requires no flow divider valve, providing efficient transmission of power from the pumps to the motors with minimal pressure drops.

Hydraulic hoses for the front wheel drive are positioned high up, safely out of harm's way. AWD monitoring is integrated with the Contronics system, ensuring extensive safeguards for lasting reliability.

When the going gets tough

Volvo All Wheel Drive can deliver up to 3 855 kg (8,500 lb) of additional rim pull at the front wheels for increased blade loads. With 16 selectable levels of aggression, operators can match traction to any operating conditions. With high start-up torque capability, Volvo AWD performance raises the bar industry-wide for starting high blade loads from a full stop.

Reaching a top speed up to 37,7 km/h (23.6 mph) in 10th gear with the optional* HTE1160 transmission in AWD mode, the G946 is today's top-of-the-line for optimum snow-clearing operations or any high speed AWD application.

When fine-grading deadlines are tight, G946 Creep Mode gets you to the finish line first with ultimate precision and effortless control.

* 32,2 km/h (20.1 mph) with standard HTE840 transmission





Ultimate precision

Proven on job sites since 1999, Volvo Creep Mode sets today's benchmark for fine-grading control by allowing the operator to grade using only the hydrostatic front-wheel drive; the rear tandems roll freely behind to minimize scuffing and rework. Creep Mode is easily selected via the transmission controller. Operating at speeds under 4,0 km/h (2.5 mph), the front-wheel-only drive is controlled simply by pressing the accelerator pedal. Creep Mode allows extremely smooth starts and stops, eliminating ridges often left by the moldboard in a conventional grader. The result is more precise passes in less time to complete the job.

A MACHINE YOU CAN ALWAYS TRUST

Contronics

- Detailed real time display of system status for the operator
- Up to 25 points of interest for service diagnostics
- Monitor fuel consumption, cycle times, and service intervals

Volvo Power

- Volvo D7E US Tier 3/EU Stage IIIA engine
- V-ACT technology with three power levels
- High capacity cooling system
- Hydraulically driven, variable-speed fan with optional auto-reversing
- Planetary rear axle with clutched differential lock
- G946 all-wheel-drive model with 3 easy-to-use operating modes and 16 selectable levels of aggression

Easy To Keep

- No daily greasing or weekly servicing required
- "Easy Lift" rear hood for easy access to the radiator
- Large lockable engine panels
- Convenient ground level refueling
- Sight glasses at tandems, final drive hydraulic tank for quick level checks
- Optional 500-hour engine oil change interval
- Large capacity hydraulic filter

Volvo Transmissions

- Choice of transmissions designed expressly for motor graders
- Shuttle shift for effortless forward/reverse shifts
- Standard HTE840 with full power shift
- Optional Autoshift on HTE840
- Optional 11-speed HTE1160 with Autoshift included
- Manual, Autoshift and Travel modes optimize performance and fuel economy

Volvo Grader Frame

- Rugged front and rear frames support a full range of attachments
- Full-perimeter rear frame isolates powertrain from attachment stresses and vibration



Volvo Care Cab

- Industry-standard operating controls
- Ergonomic low-effort, short-throw levers; adjustable
- Enclosed ROPS/FOPS compartment lives up to every expectation for industry-leading comfort, safety and efficiency
- Wide-angle visibility reduces operator fatigue, increases productivity and maximizes safety
- Interior and exterior mirrors provide clear wide-angle view to the sides and rear

Volvo Circle Turn

- Twin-gear direct-drive circle turn system
- Teeth cut on outside of circle provide ability to hold or turn the moldboard smoothly while moving under full load
- Two direct-acting hydraulic cylinders, 90° out of phase
- Maximum load handling strength with fewer moving parts

Blade Control

- Wide-stance blade lift cylinders for fine grading stability
- Wide range of moldboard positions for banking or ditching
- Easily replaceable moldboard slide bearings
- Optional blade widths available with extensions and cutting edges

PDF Hydraulics

- "Proportional Demand Flow" intelligent closed center, load-sensing system
- Variable displacement axial piston pump for excellent multi-function control
- Minimal connections for high reliability, low service requirements
- Separate hydraulic fan-drive improves efficiency, reducing fuel consumption

Balance Of Power

- Weight and power balanced for optimum blade down force and drawbar pull values
- Purpose-built front axle with high center ground clearance and tight turning radius



SPECIFICATIONS

Base operating weight - approximate

Weights shown include enclosed low profile cab with ROPS, all operating fluids, operator and standard equipment.

		G930	G940	G946	G960
Base - Total	kg (lb)	15 800 (34,830)	16 400 (36,150)	17 300 (38,140)	17 550 (38,690)
On front wheels	kg (lb)	4 700 (10,360)	4 700 (10,360)	5 000 (11,020)	5 100 (11,240)
On rear wheels	kg (lb)	11 100 (24,470)	11 700 (25,790)	12 300 (27,120)	12 450 (27,450)
Maximum combined capacity	kg (lb)	19 280 (42,500)	21 320 (47,000)	21 770 (48,000)	21 860 (48,200)
Maximum weight - front	kg (lb)	7 570 (16,700)	7 570 (16,700)	7 570 (16,700)	7 570 (16,700)
Maximum weight - rear	kg (lb)	14 240 (31,400)	14 240 (31,400)	14 240 (31,400)	14 290 (31,500)

Note that adding weight and attachments to the base grader may necessitate a tire upgrade as maximum weight capacity of tire may be exceeded.

Productivity (Standard equipment)

Blade pull at base weight (0.9 traction co-efficient)	kg (lb)	9 990 (22,023)	10 530 (23,211)	14 925 (32,908)	11 205 (24,705)
Blade pull at maximum base weight (0.9 traction co-efficient)	kg (lb)	12 816 (28,260)	12 816 (28,260)	16 671 (36,760)	12 861 (28,350)
Blade down force capability	kg (lb)	8 188 (18,021)	8 131 (17,895)	8 650 (19,035)	8 823 (19,421)

Blade down force is the maximum downward force which may be applied at the cutting edge.

Engine data

Model		Volvo D7E	Volvo D7E	Volvo D7E	Volvo D7E
Turbocharged, aftercooled with replaceable wet-type cylinder liners.					
No. of cylinders		In Line 6	In Line 6	In Line 6	In Line 6
Bore & stroke	mm (in)	108 x 130 (4.25 x 5.12)	108 x 130 (4.25 x 5.12)	108 x 130 (4.25 x 5.12)	108 x 130 (4.25 x 5.12)
Displacement	l (cu in)	7,2 (436)	7,2 (436)	7,2 (436)	7,2 (436)
Engine certified to US EPA Tier 3/EU Stage IIIA exhaust emission standards.					
Electrical system		24 volt - 1920 watt (80 amp) alternator	24 volt - 1920 watt (80 amp) alternator	24 volt - 1920 watt (80 amp) alternator	24 volt - 1920 watt (80 amp) alternator
Batteries (two 12 volt) maintenance free, heavy duty		760 CCA 170 RC	760 CCA 170 RC	1125 CCA 195 RC	760 CCA 170 RC

Two 12 volt 1125 CCA (195 RC) or 1300 CCA (385 RC) batteries available optionally.

Engine performance curve

Legend

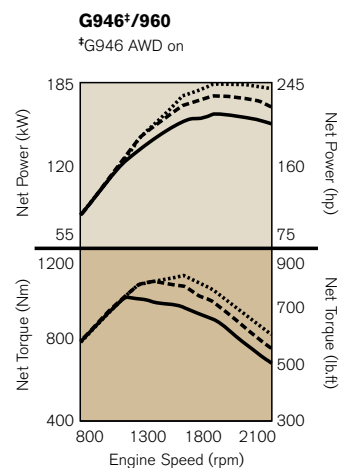
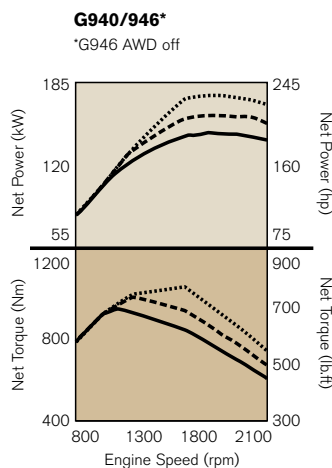
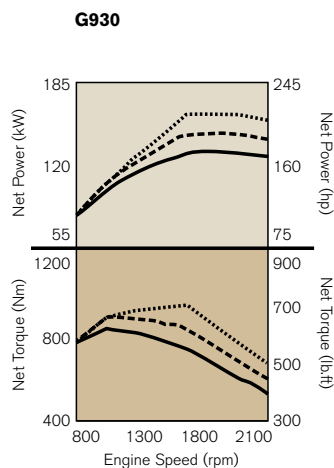
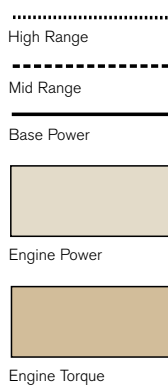

		G930	G940 G946 AWD off	G946 AWD on	G960
3 Range engine power control					
Base range power					
Rated net brake horsepower @ 1900 RPM [§]	kW (hp)	115 (155)	130 (175)	145 (195)	145 (195)
Torque	N.m (lb.ft)	906 (668) @1200	987 (728) @1200	1 047 (772) @1300	1 047 (772) @1300
Mid range power					
Rated net brake horsepower @ 1900 RPM [§]	kW (hp)	130 (175)	145 (195)	160 (215)	160 (215)
Torque	N.m (lb.ft)	915 (675) @1400	1 010 (745) @1400	1 066 (786) @1500	1 066 (786) @1500
High range power					
Rated net brake horsepower @ 2100 RPM [§]	kW (hp)	145 (195)	160 (215)	175 (235)	175 (235)
Maximum net horsepower @ 1800 RPM	kW (hp)	154 (204)	168 (225)	180 (242)	180 (242)
Torque	N.m (lb.ft)	928 (684) @1550	1 023 (754) @1550	1 073 (791) @1500	1 073 (791) @1500
Engine de-rating at 3 000 m (9,800 ft) altitude		None	None	4%	4%
Rated net horsepower SAE J1349/ISO 9249					

[§]Optional, operator controlled Power / Speed Engine Mode allows 2100 RPM in Base and Mid power ranges. Not available in the European Union.

Transmission

Fully sequential, direct drive, Volvo powershift transmission. Engine cannot be started if transmission is in gear. Single lever electronic transmission controller provides self-diagnostics and overspeed protection. Optional HTE1160 has automatic shifting and travel mode as standard equipment.

Approximate values - ground speeds may vary based upon tire brand

Transmission	HTE840 8-Speed			HTE1160 11-Speed	
	Tire Size	14:00		17.5	14:00
Gear @ RPM	km/h (mph)	km/h (mph)	Gear @ RPM	km/h (mph)	km/h (mph)
F1 @ 1900	3,8 (2.4)	3,8 (2.4)	F1 @ 1900	3,0 (1.9)	2,9 (1.8)
F2 @ 1900	5,3 (3.3)	5,3 (3.3)	F2 @ 1900	3,9 (2.4)	3,8 (2.4)
F3 @ 1900	7,5 (4.7)	7,4 (4.6)	F3 @ 1900	5,2 (3.2)	5,1 (3.2)
F4 @ 1900	10,5 (6.5)	10,3 (6.5)	F4 @ 1900	6,7 (4.2)	6,6 (4.1)
F5 @ 1900	14,9 (9.3)	14,7 (9.2)	F5 @ 1900	8,8 (5.5)	8,7 (5.4)
F6 @ 2100	20,8 (13.0)	20,5 (12.8)	F6 @ 1900	11,4 (7.1)	11,2 (7.0)
F7 @ 2100	32,2 (20.1)	31,8 (19.9)	F7 @ 1900	16,6 (10.4)	16,4 (10.3)
F8 @ 2100	44,9 (28.1)	44,4 (27.7)	F8 @ 2100	22,2 (13.9)	21,9 (13.7)
			F9 @ 2100	28,8 (18.0)	28,4 (17.8)
			F10 @ 2100	37,7 (23.6)	37,2 (23.3)
			F11 @ 2100	48,8 (30.5)	48,2 (30.1)
R1 @ 1900	3,8 (2.3)	3,7 (2.3)	R1 @ 1900	2,9 (1.8)	2,9 (1.8)
R2 @ 1900	7,4 (4.6)	7,3 (4.5)	R2 @ 1900	5,1 (3.2)	5,0 (3.1)
R3 @ 1900	14,6 (9.1)	14,4 (9.0)	R3 @ 1900	8,6 (5.4)	8,5 (5.3)
R4 @ 2100	31,6 (19.8)	31,2 (19.5)	R4 @ 1900	12,6 (7.9)	12,5 (7.8)
			R5 @ 2100	21,8 (13.6)	21,5 (13.5)
			R6 @ 2100	37,1 (23.2)	36,6 (22.9)

Engine Power Range	Transmission Gear	
	Volvo HTE840	Volvo HTE1160
Base	F1, F2 R1	F1, F2, F3 R1, R2
Mid	F3, F4, F5 R2, R3	F4, F5, F6, F7 R3, R4
High	F6, F7, F8 R4	F8, F9, F10, F11 R5, R6

		G930	G940	G946	G960
Tandems					
Depth	mm (in)	226,5 (8.9)	226,5 (8.9)	226,5 (8.9)	226,5 (8.9)
Height	mm (in)	616 (24.25)	616 (24.25)	616 (24.25)	616 (24.25)
Thickness					
inner wall	mm (in)	25 (1)	25 (1)	25 (1)	25 (1)
outer wall	mm (in)	20 (.78)	20 (.78)	20 (.78)	20 (.78)
Center distance	mm (in)	1 550 (61)	1 550 (61)	1 550 (61)	1 550 (61)
Drive chain pitch	mm (in)	51 (2)	51 (2)	51 (2)	51 (2)
Oscillation	degrees ±	15°	15°	15°	15°
Differential / Final drive					
Model		Volvo APR70	Volvo APR70	Volvo APR70	Volvo APR70
Planetary final reduction with an operator controlled wet multiple disc lock/unlock differential.					
Wheels & tires (Standard equipment)					
Tire size		14:00 x 24, G-2	14:00 x 24, G-2	14:00 x 24, G-2	14:00 x 24, G-2
Ply rating (PR)		12	12	12	12
Rim size	mm (in)	223 (9) One piece rim	223 (9) One piece rim	254 (10) Three piece rim	254 (10) One piece rim
Bolt-on rims interchangeable between front and rear					
		Yes	Yes	No	Yes
Front axle and articulation					
Wheel lean	degrees R & L	18°	18°	18°	18°
Oscillation	degrees up & down	16°	16°	16°	16°
Ground clearance	mm (in)	610 (24)	610 (24)	610 (24)	610 (24)
Minimum turning radius using front axle steering, articulation, wheel lean and unlocked differential	mm (ft)	7 265 (23'10")	7 265 (23'10")	7 265 (23'10")	7 265 (23'10")
Steering arc	degrees	50°	50°	50°	50°
Frame articulation angle	degrees	23°	23°	23°	23°
Anti-drift lock valve ensures stable operation. Articulation lock standard.					
Hydrostatic power steering of front wheels incorporating two steering cylinders. Meets SAE J1511 FEB. 94, ISO 5010:1992, EN12643:1997 with optional secondary steering.					
Brakes					
Service Brakes: Foot operated					
Fade resistant, hydraulically actuated, wet multiple disc service brakes located at the 4 tandem drive wheels are fully sealed and maintenance free. System features crossover dual braking circuits for uniform braking on both sides of the grader. Includes reserve power assist and operator warning system (visual and audible).					
Parking Brake					
Spring applied hydraulically released enclosed wet multiple disc type parking brake in final drive. Effective on all 4 tandem drive wheels. Transmission cannot be engaged with park brake on.					
Braking systems comply to SAE J/EN ISO 3450:1996.					
Volvo uses asbestos free brake components.					

		G930	G940	G946	G960
Front Frame Fabricated – Robotically welded					
Minimum dimensions of box section	mm (in)	265 x 340 (10.5 x 13.5)	265 x 340 (10.5 x 13.5)	265 x 340 (10.5 x 13.5)	265 x 340 (10.5 x 13.5)
Plate thickness sides, top & bottom	mm (in)	20 (.79)	20 (.79)	20 (.79)	25 & 30 (1 & 1.2)
Vertical section modulus at arch	cm ³ (cu in)	1 950 (119)	1 950 (119)	2 671 (163)	2 671 (163)
minimum	cm ³ (cu in)	1 663 (101)	1 663 (101)	2 256 (138)	2 256 (138)
maximum	cm ³ (cu in)	3 474 (212)	3 474 (212)	4 652 (284)	4 652 (284)
Rear Frame – Full perimeter type					
Minimum dimensions of side rail	mm (in)	254 x 100 (10 x 4)	254 x 100 (10 x 4)	254 x 100 (10 x 4)	305 x 100 (12 x 4)
Side plate thickness	mm (in)	9,6 (.38)	12,7 (.5)	12,7 (.5)	25,4 (1)
Optional first user lifetime warranty on frame, includes maintenance free articulation pins and bearings.					
Moldboard					
Standard moldboard with replaceable end bits	mm (in)	22 x 635 x 3 658 (.87 x 25 x 12')	22 x 635 x 3 658 (.87 x 25 x 12')	22 x 635 x 3 658 (.87 x 25 x 12')	22 x 635 x 3 658 (.87 x 25 x 12')
Moldboard material		SAE 1050 high carbon steel	SAE 1050 high carbon steel	SAE 1050 high carbon steel	SAE 1050 high carbon steel
Edge: through hardened	mm (in)	152 x 16 (6 x 5/8) boron steel	152 x 16 (6 x 5/8) boron steel	152 x 16 (6 x 5/8) boron steel	152 x 16 (6 x 5/8) boron steel
Bolt spacing	mm (in)	152 (6)	152 (6)	152 (6)	152 (6)
Bolt size	mm (in)	16 (5/8)	16 (5/8)	16 (5/8)	16 (5/8)
Slide rails supported by Duramide™ bearings		YES	YES	YES	YES
Moldboard range: Moveable Blade Control System					
(Dimensions shown with standard 14:00 tires and moldboard)		Left/Right	Left/Right	Left/Right	Left/Right
Reach outside tires - articulated frame	mm (in)	3 048/3 035 (120/119.5)	3 048/3 035 (120/119.5)	3 048/3 035 (120/119.5)	3 048/3 035 (120/119.5)
Reach outside tires - straight frame	mm (in)	2 020/2 010 (80/79)	2 020/2 010 (80/79)	2 020/2 010 (80/79)	2 020/2 010 (80/79)
Moldboard slide	mm (in)	673/673 (26.5/26.5)	673/673 (26.5/26.5)	673/673 (26.5/26.5)	673/673 (26.5/26.5)
Circle side shift	mm (in)	775/749 (30.5/29.5)	775/749 (30.5/29.5)	775/749 (30.5/29.5)	775/749 (30.5/29.5)
Maximum bank sloping angle, left - right	degrees	90°/90°	90°/90°	90°/90°	90°/90°
7 Position Blade Control system linkage		YES	YES	YES	YES
Moldboard ground clearance	mm (in)	445 (17.5)	445 (17.5)	445 (17.5)	445 (17.5)
Moldboard cutting depth	mm (in)	790 (31)	790 (31)	790 (31)	790 (31)
Moldboard tilt range	degrees forward degrees back	47° 5°	45° 6°	45° 6°	45° 6°
Superior moldboard mobility permits steep ditch cutting angles and back sloping outside overall machine width.					

		G930	G940	G946	G960
Circle					
Pitch diameter	mm (in)	1 626 (64)	1 626 (64)	1 626 (64)	1 626 (64)
Thickness	mm (in)	32 (1.25)	32 (1.25)	32 (1.25)	32 (1.25)
Adjustable guide shoes - standard / optional		3 / 5	3 / 5	3 / 5	3 / 5
Adjustable clamp plates - standard / optional		3 / 5	3 / 5	3 / 5	3 / 5
Upper circle wear plates - standard / optional		3 / 5	3 / 5	3 / 5	3 / 5

Circle to drawbar support is provided by Duramide™ wear plates and bearings at the clamp and guide shoes. Duramide™ prevents metal-to-metal contact and provides maximum service life.

Circle drive

The Volvo dual gear Circle Drive System uses direct acting hydraulic power for exceptional turning and holding capability under full load. Circle Drive System uses two hardened drive pinions and is protected against impact damage by an overload relief valve as standard equipment.

Rotation	degrees	360°	360°	360°	360°
----------	---------	------	------	------	------

Drawbar

Dimensions of box section	mm (in)	165 x 165 (6.5 x 6.5)	165 x 165 (6.5 x 6.5)	165 x 165 (6.5 x 6.5)	165 x 165 (6.5 x 6.5)
Plate thickness	mm (in)	25 & 19 (1 & .75)	25 & 19 (1 & .75)	25 & 19 (1 & .75)	25 & 19 (1 & .75)

Cab & controls

Low profile cab with ROPS/FOPS

Interior height	mm (in)	1 620 (64)	1 620 (64)	1 620 (64)	1 620 (64)
-----------------	---------	------------	------------	------------	------------

An optional full height cab is available with an inside height of 1 837 mm (72.5").

All Volvo Grader cabs and canopies are designed to meet or exceed SAE J/ISO 3471-1:2004 and EN 13510:2000 ROPS requirements and SAE J/ISO 3449:2005 Level 2 FOPS requirements.

The retractable seatbelt is 76 mm (3") wide and meets SAE J386 NOV. 97 and EN ISO 6683:1999. Industry standardized control lever arrangement.

Interior operator noise levels average 72 dB(A) per ISO 6394:1998 (enclosed cab).

Implement hydraulics

Circuit type: Closed center, load sense Proportional Demand Flow (PDF) Hydraulic System, with O-ring face seal hose connections.

Main implement pump type		Axial piston type	Axial piston type	Axial piston type	Axial piston type
Maximum pressure	Bar (psi)	207 (3,000)	207 (3,000)	207 (3,000)	207 (3,000)
Output 2100 RPM	lpm (gpm)	208 (55)	208 (55)	208 (55)	208 (55)
Stand by pressure	Bar (psi)	24 (350)	24 (350)	24 (350)	24 (350)

Large capacity, replaceable in-tank filter. Filters both system and re-fill oil. Low level and high temperature operator warning.

Hydraulic fan drive pump

Separate axial piston pump dedicated to the variable speed cooling fan. Reversible cooling fan optionally available.

		G930	G940	G946	G960
Capacities					
Fuel tank	l (U.S. Gal.)	340 (90)	400 (105)	400 (105)	400 (105)
Transmission	l (U.S. Gal.)	61 (16)	61 (16)	61 (16)	61 (16)
Final drive	l (U.S. Gal.)	22,7 (6)	22,7 (6)	22,7 (6)	22,7 (6)
Tandems (each)	l (U.S. Gal.)	100 (26.4)	100 (26.4)	100 (26.4)	100 (26.4)
Hydraulic oil tank	l (U.S. Gal.)	91 (24)	91 (24)	144 (38)	91 (24)
Coolant antifreeze protection to -50° C (-58° F) approx	l (U.S. Gal.)	31 (8.2)	31 (8.2)	34 (9.0)	34 (9.0)
Engine oil	l (U.S. Gal.)	21,5 (5.7)	21,5 (5.7)	21,5 (5.7)	21,5 (5.7)
Attachments					
(Optional unless otherwise stated as standard equipment)					
Push Block	kg (lb)	515 (1,138)	515 (1,138)	515 (1,138)	515 (1,138)
Ripper includes rear frame arch support and links	kg (lb)	1 495 (3,295)	1 495 (3,295)	1 495 (3,295)	1 495 (3,295)
Mid Mount Scarifier	kg (lb)	905 (1,995)	905 (1,995)	905 (1,995)	905 (1,995)
Front Mount Scarifier	kg (lb)	715 (1,575)	715 (1,575)	715 (1,575)	715 (1,575)
Dozer: 2,4 m (8')	kg (lb)	1 080 (2,380)	1 080 (2,380)	1 080 (2,380)	1 080 (2,380)
2,7 m (9')	kg (lb)	1 140 (2,515)	1 140 (2,515)	1 140 (2,515)	1 140 (2,515)
All Wheel Drive					
Maximum operating pressure	Bar (psi)			345 (5,000)	
Minimum operating pressure	Bar (psi)			34 (500)	
Top speed with AWD engaged	km/h (mph)			33 (20.4)	
Maximum rim pull	kg (lb)			3 855 (8,500)	

When equipped with the HTE840 transmission, the Volvo high torque All Wheel Drive System operates in forward gears 1-7 and reverse gears 1-4.

When equipped with the HTE1160 transmission, the Volvo high torque All Wheel Drive System operates in forward gears 1-10 and reverse gears 1-6.

System provides the operator with the ability to fine grade in Creep Mode using only hydrostatic front wheel drive, between 0 - 4 km/h (0 - 2.5 mph).

		G930	G940	G946	G960
Dimensions					
All dimensions are approximate.					
A	mm (in)	8 930 (352)	9 150 (360)	9 150 (360)	9 150 (360)
B	mm (in)	2 675 (105)	2 650 (104)	2 650 (104)	2 650 (104)
C	mm (in)	6 280 (247)	6 280 (247)	6 280 (247)	6 280 (247)
D	mm (in)	2 076 (82)	2 076 (82)	2 076 (82)	2 076 (82)
E	14:00 mm (in)	2 537 (100) STD	2 537 (100) STD	2 537 (100) STD	2 537 (100) STD
	17.5 mm (in)	2 717 (107)	2 717 (107)	2 717 (107)	2 717 (107)
F	mm (in)	3 225 (127)	3 225 (127)	3 225 (127)	3 225 (127)

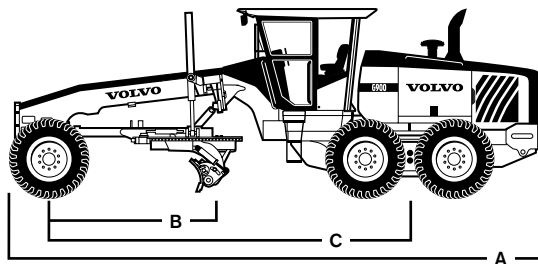
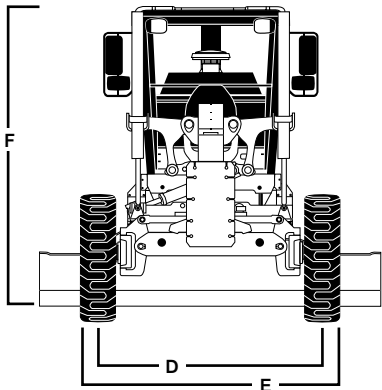

Legend

- A = Overall length
- B = Bladebase per ISO 7134
- C = Wheelbase
- D = Width - Front tire center lines
- E = Width - Outside tires
- F = Overall height with Low Profile Cab
Add 217 mm (8.5") for full height cab

STANDARD FEATURES / OPTIONAL EQUIPMENT

Model (S - Standard / O - Optional)	G930	G940	G946	G960	G970	G976	G990
Powertrain							
Volvo engines are certified to US Tier 3/EU Stage IIIA emission criteria	S	S	S	S	S	S	S
Rear axle, operator controlled, lock/unlock differential with planetary final reduction	S	S	S	S	S	S	S
4 wheel wet disc braking system with crossover dual circuits and reserve power assist	S	S	S	S	S	S	S
Spring applied wet multiple disc park brake with operator warning alarm and indicator	S	S	S	S	S	S	S
Electronic hand throttle with RPM hold and resume functions	S	S	S	S	S	S	S
Operator controlled Power/Speed engine mode (N/A in the European Union)	O	O	O	O	O	O	O
Direct drive, power shift Volvo HTE840 transmission with 8 forward and 4 reverse gears	S	S	S	S	S	S	S
Single transmission control lever, with electronic over speed protection, advanced memory shift and park position lockout with hinged transmission guard	S	S	S	S	S	S	S
Transmission Autoshift and Travel functions	O	O	O	O	O	O	O
Direct Forward to Reverse shuttle shift capability without using the Inching pedal	S	S	S	S	S	S	S
Volvo HTE1160 Transmission - 11 speeds forward 6 speeds reverse includes Autoshift and travel functions	O	O	O	O	O	O	O
Hydraulically driven – variable speed cooling fan	S	S	S	S	S	S	S
Reversible cooling fan - manual or automatic modes	O	O	O	O	O	O	O
Automatic engine protection lowers engine torque and speed if critical conditions occur	S	S	S	S	S	S	S
Electrical							
Cab mounted headlights with dimmer switch	S	S	S	S	S	S	S
Lights; backup, tail, stop and directional	S	S	S	S	S	S	S
Backup alarm 112 dB(A)	S	S	S	S	S	S	S
Moldboards work lights - 2 or 4	O	O	O	O	O	O	O
Rear work lights - 2 or 4	O	O	O	O	O	O	O
Corner cab work lights - left or right - 2	O	O	O	O	O	O	O
2460 watt (110 amp) alternator	O	O	O	O	O	O	O
24 volt to 12 volt converter - 600 or 1440 watt (30 or 60 amp) with power point	O	O	O	O	O	O	O
Productivity							
Heavy duty circle support system	O	O	O	O	O	O	S
Metallic lower moldboard slide bearing	O	O	O	O	O	O	S
Hinged cooling module fan door for easy trash clean out	S	S	S	S	S	S	S
Ground level fueling	S	S	S	S	S	S	S
Lockable tool box with storage space for scarifier shanks	S	S	S	S	S	S	S
Brackets for Automatic Blade Control System installation	O	O	O	O	O	O	O
Under side rear guards	O	O	O	O	O	O	O
Parts and Service Manual on CD - English only	O	O	O	O	O	O	O
Front fenders/lean and steer with tire - plastic	O	O	O	O	O	O	O
Rear fenders – oscillates with tandem - steel	O	O	O	O	O	O	O
Hydraulics							
Proportional Demand Flow hydraulic system with short throw, low effort control levers	S	S	S	S	S	S	S
10 section hydraulic control valve - includes two spare sections with levers	S	S	S	S	S	S	S
Circle turn relief located integral with main manifold	S	S	S	S	S	S	S
Hydraulic oil level monitor via Contronics	S	S	S	S	S	S	S
Blade Lift Float Control, independent right and left detent style	O	O	O	O	O	O	O
Front attachment float control, detent style, independent of other float valves	O	O	O	O	O	O	O
Up to 5 additional remote valve locations for attachments	O	O	O	O	O	O	O
Blade lift accumulators – operator controlled from cab	S	S	S	S	S	S	S
Secondary steering (power assisted)	O	O	O	O	O	O	O
Other							
First user lifetime frame warranty – includes articulation pins and bearings	O	O	O	O	O	O	O
Low ambient fluids for extreme cold conditions below -10° C (-14° F)	O	O	O	O	O	O	O
Sound reduction packages (Standard in EU markets)	O	O	O	O	O	O	O
Rear licence plate bracket	O	O	O	O	O	O	O
Air compressor - engine driven with tank capable of operating hand tools	O	O	O	O	O	O	O
Volvo CareTrack – remote monitoring system	O	O	O	O	O	O	O

Model (S - Standard / O - Optional)	G930	G940	G946	G960	G970	G976	G990
Operator Cab							
Two lockable operator cab doors complete with inside and ground level releases	S	S	S	S	S	S	S
Illuminated entry when cab doors are opened - enclosed cab only	S	S	S	S	S	S	S
Adjustable steering control pedestal with tilt head for maximum operator comfort	S	S	S	S	S	S	S
Gauges include: coolant temperature, engine oil pressure, fuel level, hourmeter, articulation angle indicator	S	S	S	S	S	S	S
Multi-function Volvo Contronic Monitoring System with visual and audible warnings	S	S	S	S	S	S	S
Deluxe, cloth covered, fully adjustable suspension seat when grader is equipped with an enclosed cab - 75 mm (3") retractable seatbelt	S	S	S	S	S	S	S
Deluxe air suspension, cloth covered, fully adjustable suspension seat - 75 mm (3") retractable seatbelt	O	O	O	O	O	O	O
Left and right outside dual rear view mirrors	S	S	S	S	S	S	S
Fold-away left and right outside dual rear view mirrors	O	O	O	O	O	O	O
Heated outside left and right dual rear view mirrors	O	O	O	O	O	O	O
Dual interior rear view mirrors	S	S	S	S	S	S	S
Enclosed Low Profile Cab with ROPS and FOPS – left and right cab door with steps	S	S	S	S	S	S	S
Enclosed High Profile Cab with ROPS and FOPS – left and right cab door with steps	O	O	O	O	O	O	O
Low Profile canopy shell (SPLIT) with ROPS – left and right entry with steps	O	O	O	O			
Cab heater - 50,000 BTU with cab pressurizer and replaceable filters, 10 outlets	S	S	S	S	S	S	S
Air conditioner - 35,000 BTU • HFC-134a (non-CFC refrigerant) with cab heater	O	O	O	O	O	O	O
Defroster fan with 5 outlets directed at front windows and doors	O	O	O	O	O	O	O
Radio/CD player with 4 concealed speakers in head liner	O	O	O	O	O	O	O
Single arm front cab wiper and washer, enclosed cab	S	S	S	S	S	S	S
Single arm wiper and washer - rear window	O	O	O	O	O	O	O
Single arm wiper and washer - lower windows front left & right	O	O	O	O	O	O	O
Dual arm front windshield, increased coverage, Low Profile Cab only	O	O	O	O	O	O	O
Intermittent wipers on all wipers ordered	O	O	O	O	O	O	O
Window - lower front - opening	O	O	O	O	O	O	O
Window - left/right side - opening sliders with multiple position openings	O	O	O	O	O	O	O
Lower cab shield, encloses bottom of cab to frame	O	O	O	O	O	O	O

Model (S - Standard / O - Optional)	G930	G940	G946	G960	G970	G976	G990
Tires and Rims - Availability and approximate weight increase from base operating weight							
Tires - Consult your Volvo dealer for full offering							
14:00 x 24 Bias	S	S	S	S	S	S	
14:00 x 24 Radial kg (lb)	185 (410)	185 (410)	185 (410)	185 (410)	185 (410)	185 (410)	
17.5 x 25 Bias kg (lb)	120 (265)	120 (265)	120 (265)	120 (265)	120 (265)	120 (265)	
17.5 x 25 Radial kg (lb)	280 (615)	280 (615)	280 (615)	280 (615)	280 (615)	280 (615)	
16:00 x 24 Bias kg (lb)					310 (685)	310 (685)	S
16:00 x 24 Radial kg (lb)					510 (1,125)	510 (1,125)	200 (440)
20.5 x 25 Bias kg (lb)					445 (980)		130 (285)
20.5 x 25 Radial kg (lb)					605 (1,335)		295 (650)
Rims							
229 x 610 mm (9" x 24") one-piece	S	S					
254 x 610 mm (10" x 24") one-piece kg (lb)	25 (55)	25 (55)		S	S		S
254 x 610 mm (10" x 24") three-piece kg (lb)	200 (440)	200 (440)	S	175 (385)	175 (385)	S	175 (385)
330 x 635 mm (13" x 25") one-piece kg (lb)	105 (230)	105 (230)	105 (230)	105 (230)	105 (230)	105 (230)	
356 x 635 mm (14" x 25") three-piece kg (lb)	330 (725)	330 (725)	330 (725)	330 (725)	330 (725)	330 (725)	
432 x 635 mm (17" x 25") three-piece kg (lb)					320 (705)		320 (705)

Moldboards - Availability and approximate weight increase from base operating weight							
3 658 x 635 x 22 mm (12' x 25" x 7/8")	S	S	S	S			
3 962 x 635 x 22 mm (13' x 25" x 7/8") kg (lb)	54 (120)	54 (120)	54 (120)	54 (120)			
4 267 x 635 x 22 mm (14' x 25" x 7/8") kg (lb)	110 (240)	110 (240)	110 (240)	110 (240)			
3 658 x 737 x 25 mm (12' x 29" x 1") kg (lb)	N/A	120 (265)	120 (265)	120 (265)	S	S	
3 962 x 737 x 25 mm (13' x 29" x 1") kg (lb)	N/A	185 (410)	185 (410)	185 (410)	65 (145)	65 (145)	
4 267 x 737 x 25 mm (14' x 29" x 1") kg (lb)	N/A	250 (550)	250 (550)	250 (550)	130 (285)	130 (285)	
4 267 x 787 x 25 mm (14' x 31" x 1")							S
4 877 x 787 x 25 mm (16' x 31" x 1") kg (lb)							160 (350)
Moldboard extensions RIGHT or LEFT - 610 mm (2')	O	O	O	O	O	O	O
Moldboard edges - carbide 19 x 127 mm (3/4" x 5") or 25 x 203 mm (1" x 8") harden steel	O	O	O	O	O	O	O

Partial listing of available options. Certain features may be standard or not available within specific market. Consult your Volvo Motor Grader distributor for more information.



Volvo Construction Equipment is different. Our machines are designed, built and supported in a different way. That difference comes from an engineering heritage of over 175 years. A heritage of thinking first about the people who actually use the machines. About how to help them be safer, more comfortable, more productive. About the environment we all share. The result of that thinking is a growing range of machines and a global support network dedicated to helping you do more. People around the world are proud to use Volvo. And we're proud of what makes Volvo different – **More care. Built in.**



Not all products are available in all markets. Under our policy of continuous improvement, we reserve the right to change specifications and design without prior notice. The illustrations do not necessarily show the standard version of the machine.

VOLVO

Volvo Construction Equipment
www.volvoce.com

Ref. No. VOE 21 C 100 2232
Printed in Sweden 2009.01
Volvo, Gøderich

English
GRD